

FIGURE 4 - PARTS LIST: MK-3024V CONCRETE SAW - P/N 166447

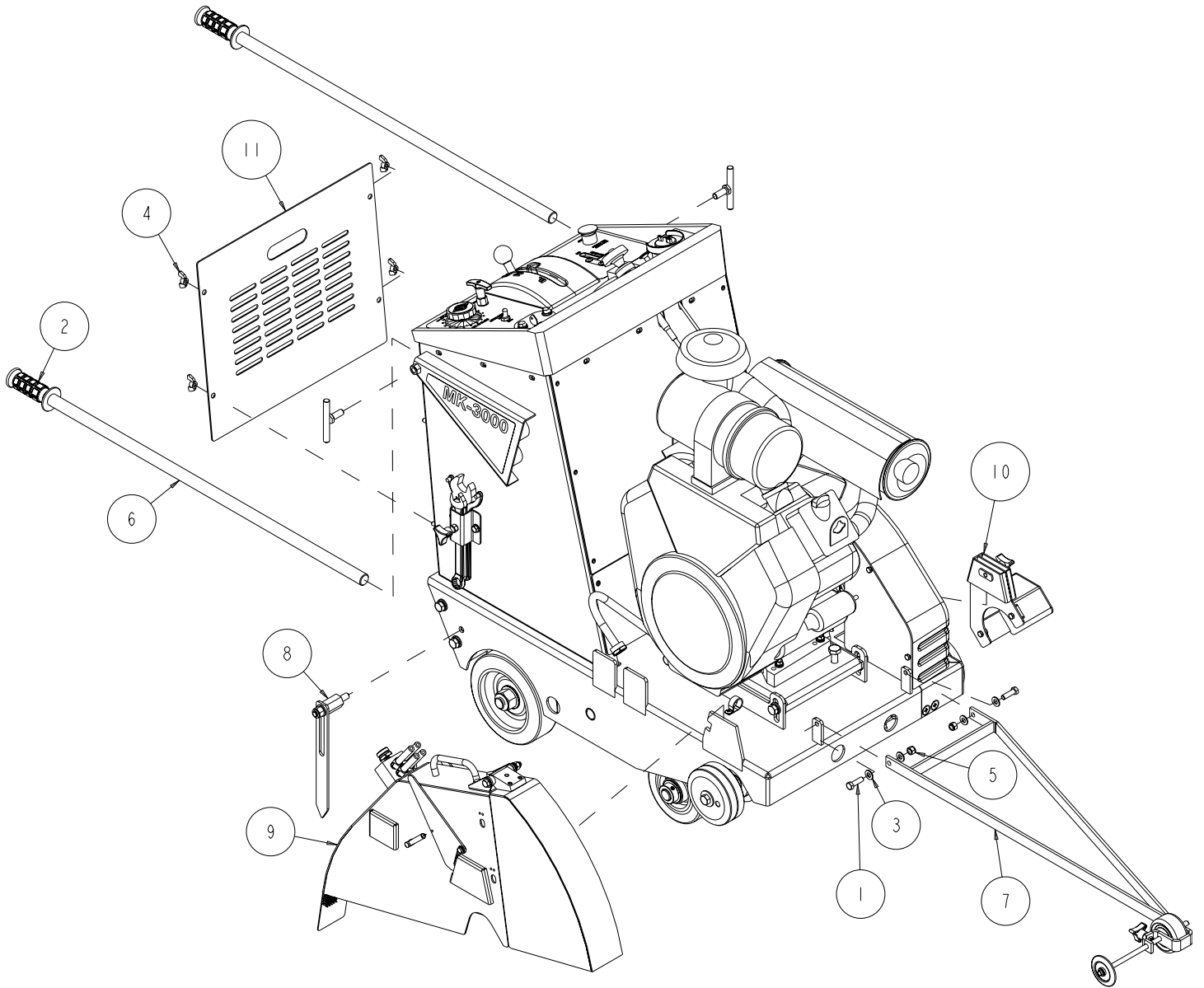

FIGURE 4 - PARTS LIST: MK-3024V CONCRETE SAW - P/N 166447

ITEM NO.	DESCRIPTION	PART OR IDENTIFYING NO.	QTY. REQ.
1	SCREW, 3/8-16 X 1-1/4 HEX HEAD CAP	150774	2
2	GRIP, HANDLE, 1.0 ID	150842	2
3	WASHER, 3/8 SAE FLAT	150923	4
4	WINGNUT, 5/16-18 NYLOK	151746	4
5	NUT, 3/8-16 NYLOK HEX	152505	2
6	HANDLEBAR	161158	2
7	ASSY, POINTER	162732	1
8	ASSY, REAR POINTER	163824	1
9	ASSY, 24" BLADE GUARD	165732	1
10	ASSY, SHAFT GUARD	166056	1
11	PANEL, TOWER LOWER BACK	166354	1

FIGURE 11 - PARTS LIST: ASSY, 24" BLADE GUARD - P/N 165732

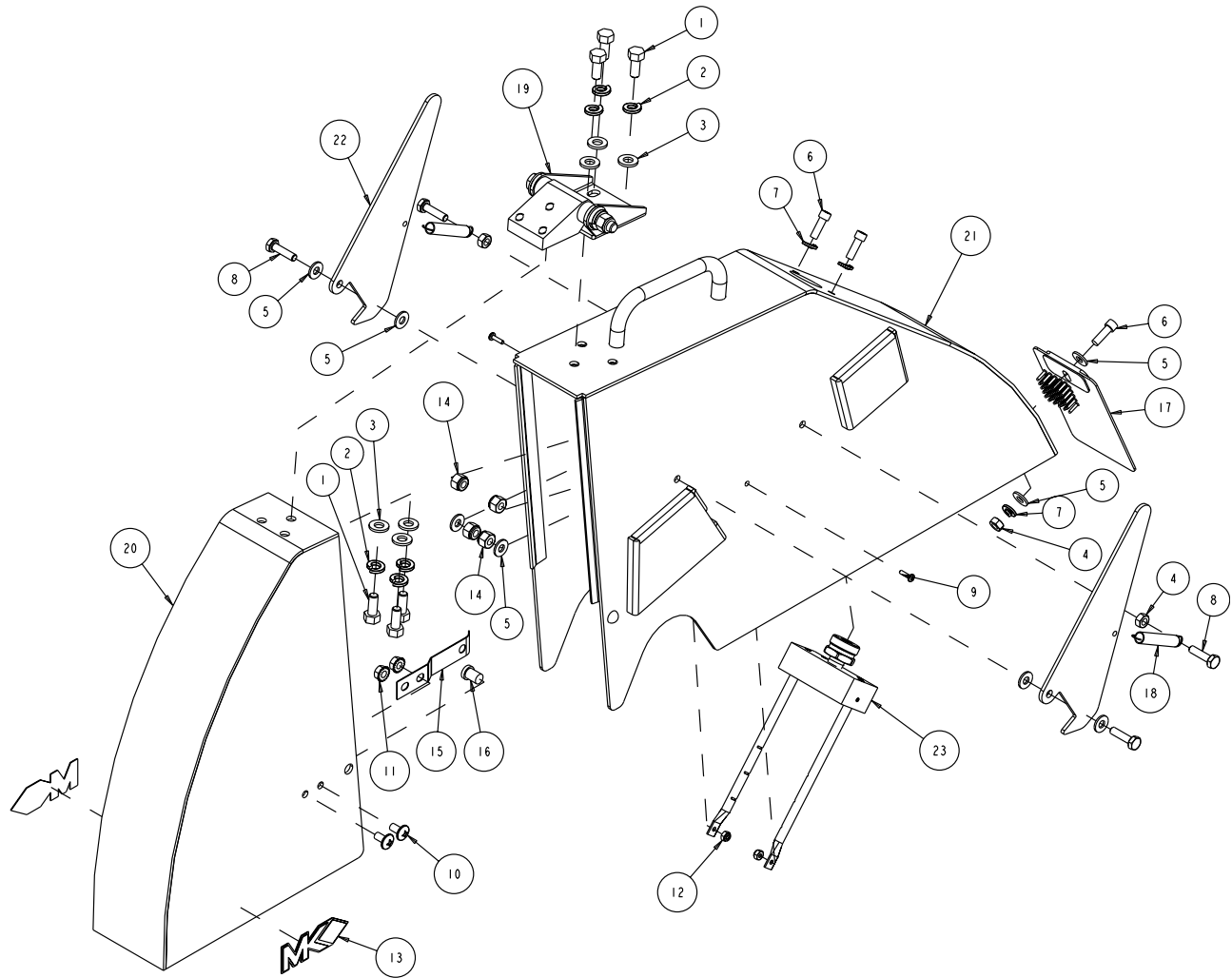

FIGURE 11 - PARTS LIST: ASSY, 24" BLADE GUARD - P/N 165732

ITEM NO.	DESCRIPTION	PART OR IDENTIFYING NO.	QTY. REQ.
1	SCREW, 5/16-18 X 3/4 HEX HEAD MACHINE	151369	6
2	WASHER, LOCK, SPLIT, 5/16	151747	6
3	WASHER, FLAT, SAE, 5/16	151754	6
4	NUT, 1/4-20 HEX	151893	3
5	WASHER, 1/4 SAE FLAT	151915	8
6	SCREW, 1/4-20 X 3/4 SOCKET HEAD CAP	152587	3
7	WASHER, 1/4 SPLIT LOCK	152591	3
8	SCREW, HEX HD CAP, 1/4-20 X 1	152676	4
9	SCREW, #6-32 X 3/8 PAN HEAD SELF TAPPING	153459	2
10	SCREW, 1/4-20 X 1/2 TRUSS HEAD	153880	2
11	NUT, HEX W/WSHR, 1/4-20	153941	2
12	NUT, HEX NYLOK 6-32	157519	2
13	LOGO, MK ADHESIVE	157914	2
14	NUT, 1/4-20 NYLOK	159857	4
15	LOCK, BLADE GUARD	159998	1
16	BUTTON, RELEASE	159999	1
17	GUARD, SPLASH	160310	1
18	SPRING, EXTENSION	160875	2
19	ASSY, HINGE	163979	1
20	GUARD, 24" FRONT BLADE	165734	1
21	GUARD, 24" REAR BLADE	165735	1
22	LATCH, 24" BLADE GUARD	165873	2
23	ASSY, WATER MANIFOLD	165877	1

FIGURE 13 - PARTS LIST: ASSY, ENGINE, 3000V - P/N 162737

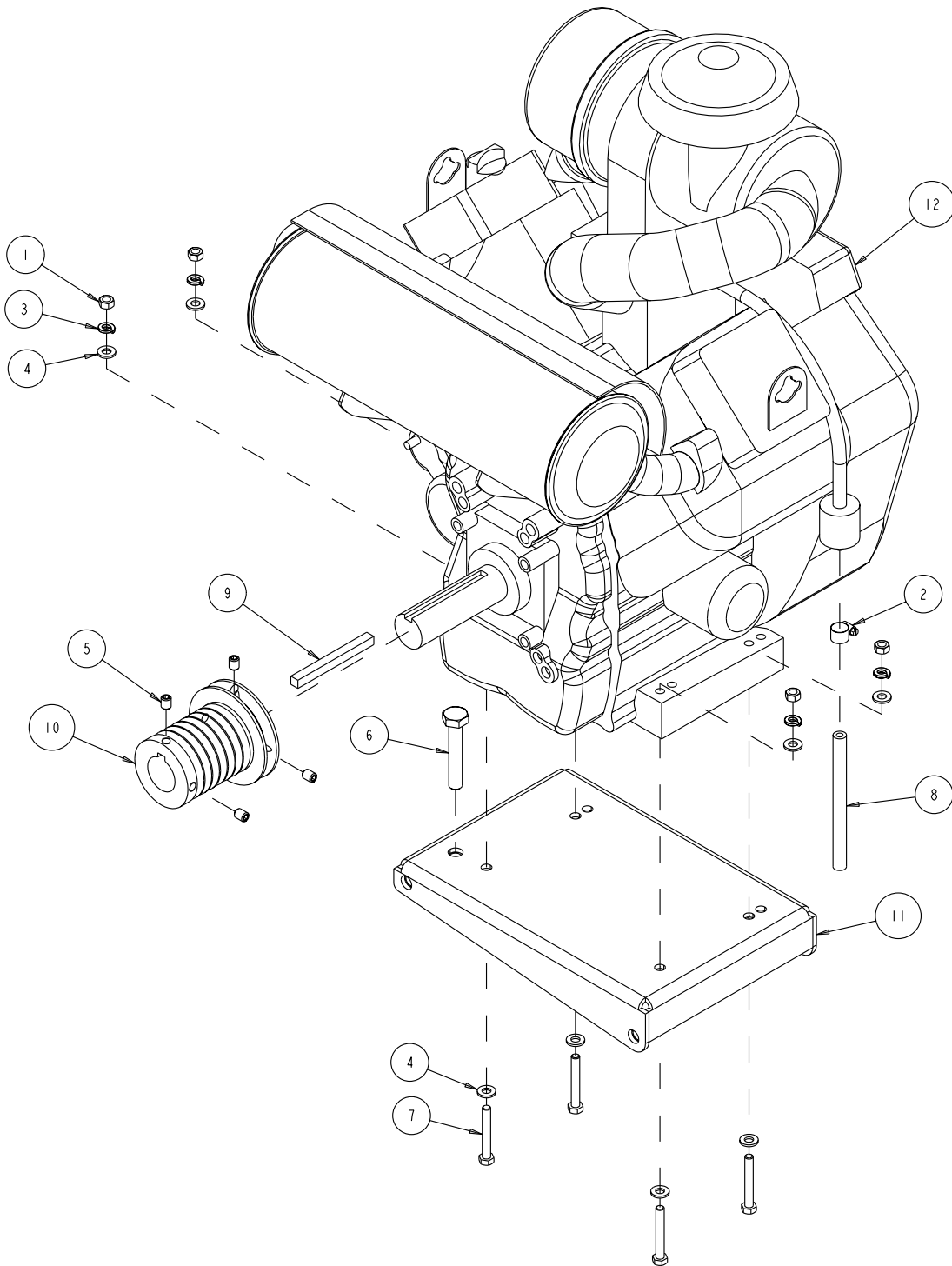
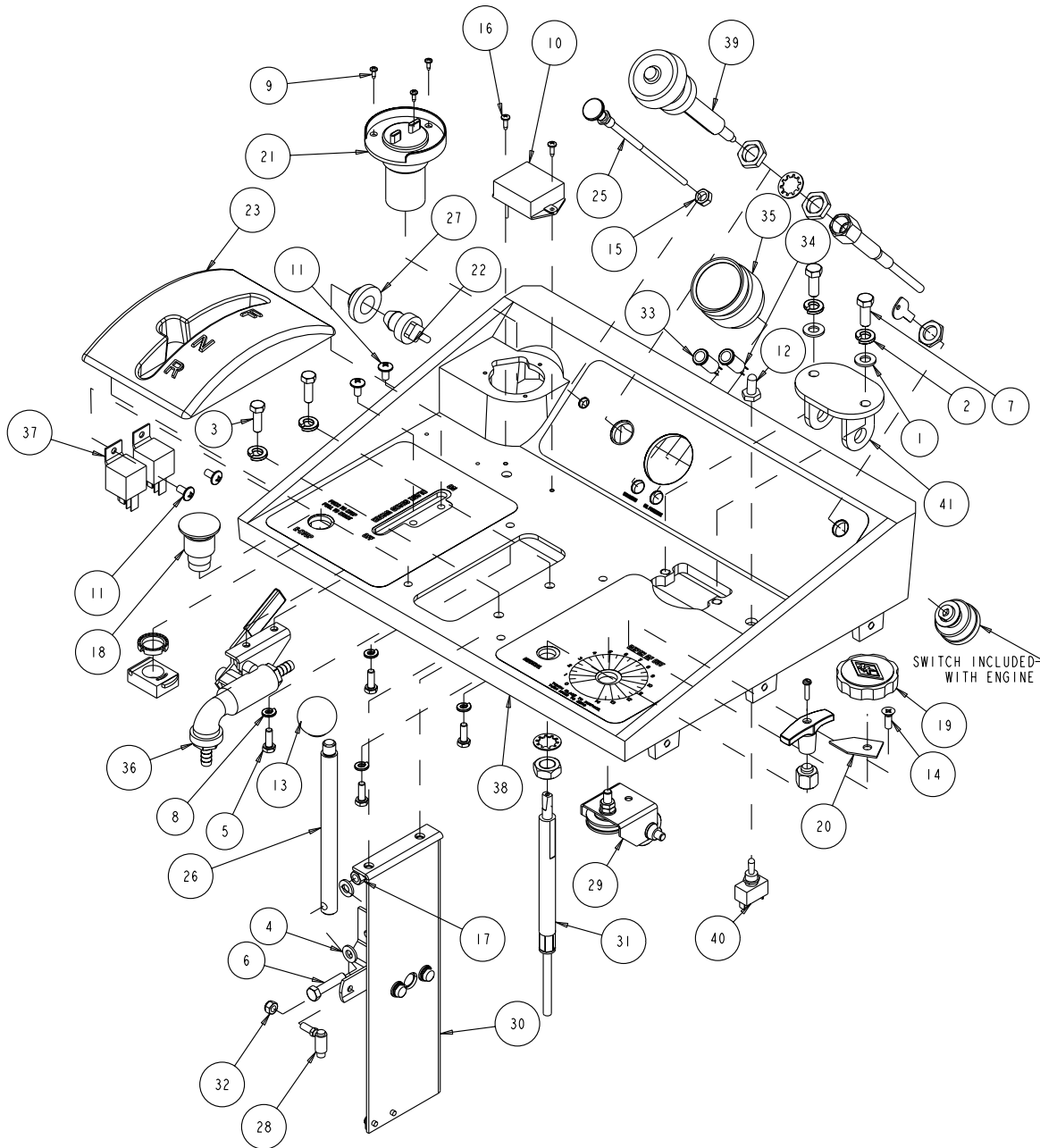

FIGURE 13 - PARTS LIST: ASSY, ENGINE, 3000V - P/N 162737

ITEM NO.	DESCRIPTION	PART OR IDENTIFYING NO.	QTY. REQ.
1	NUT, HEX, 5/16-18	101196	4
2	CLAMP, 5/8 HOSE	151198	1
3	WASHER, LOCK, SPLIT, 5/16	151747	4
4	WASHER, FLAT, SAE, 5/16	151754	8
5	SCREW, SET, SOC, CUPT, 3/8-16 X 1/2	153710	4
6	BOLT, HEX, TAP, 1/2-13 X 4	153854	1
7	SCREW, HEX, 5/16-18 X 2-1/4	153951	4
8	HOSE, 1/4 FUEL, 24"	154163	1
9	KEY, SQR, 3/8 X 4.0	154853	1
10	PULLEY, 7/3VX/2.8 X 1-7/16 BORE	165694	1
11	MOUNT, ENGINE	166348	1
12	ENGINE, B/S, VANGUARD, 35HP	166349	1

FIGURE 15 - PARTS LIST: ASSY, CONTROL PANEL, 3000V - P/N 162739



ITEM NO.	DESCRIPTION	PART OR IDENTIFYING NO.	QTY. REQ.
1	WASHER, 3/8 SAE FLAT	150923	2
2	WASHER, 3/8 SPLIT LOCK	150925	4
3	SCREW, HEX HD 5/16-18 X 1	151743	2
4	WASHER, FLAT, SAE, 5/16	151754	2

FIGURE 15 - PARTS LIST: ASSY, CONTROL PANEL, 3000V - P/N 162739

ITEM NO.	DESCRIPTION	PART OR IDENTIFYING NO.	QTY. REQ.
5	SCREW, HEX HD 1/4-20 X 3/4	152370	4
6	SCREW, 5/16-18 X 1-1/2 HEX HEAD MACHINE	152467	1
7	SCREW, HEX HD CAP, 3/8 - 16 X 1	152507	2
8	WASHER, 1/4 SPLIT LOCK	152591	4
9	SCREW, #6-32 X 3/8 PAN HEAD SELF TAPPING	153466	3
10	TACHOMETER/HOURMETER	153877	1
11	SCREW, 1/4-20 X 1/2 TRUSS HEAD	153880	4
12	COVER, SWITCH	154301	1
13	KNOB, 1/2-20 FEM BALL	154486	1
14	SCREW, 1/4-20 X 3/4 FLAT HEAD PHILLIPS MACHINE	154657	1
15	NUT, 3/4-24 HEX JAM	156632	1
16	SCREW, PAN HD SELF TAP 8-32 X 1/2	156632	2
17	NUT, 5/16 -18 NYLOK HEX	158289	1
18	ASSY, SWITCH BUTTON, GAS	162080	1
19	KNOB, DEPTH INDICATOR (COMP)	162629	1
20	POINTER, DEPTH INDICATOR	162630	1
21	FUEL FILLER W/CAP	162640	1
22	VENT, REMOTE	162641	1
23	CASTING, FNR LEVER (COMP)	162720	1
24	LABEL SHEET, CONTROL PANEL	162725	1
25	CABLE, CHOKE, WISC (COMP)	162734	1
26	SHAFT, FNR CONTROL	162740	1
27	GROMMET, REMOTE VENT	162847	1
28	BALL JOINT, 30 SERIES	162859	1
29	ASSY, DEPTH INDICATOR	162881	1
30	ASSY, CONTROLHEAD, FNR	162882	1
31	CABLE, T2L, CONTROL, N- COMP	163934	1
32	NUT, HEX, NYLK, 1/4-28	163936	1
33	LIGHT, 1/2" DIA. PANEL, RED	163938	1
34	LIGHT, 1/2" DIA. PANEL, GREEN	163939	1
35	GAUGE, FUEL, ANALOG	164151	1
36	ASSY, WATER VALVE	164161	1
37	RELAY, 12V, 70A	164969	2
38	CASTING, CONTROL PANEL, COMP	166360	1
39	CABLE, THROTTLE, 3000V COMP	166703	1
40	SWITCH, TOGGLE, (ON) OFF (ON)	167224	1
41	MOUNT, UPPER, ACTUATOR	167992	1

FIGURE 17 - PARTS LIST: ASSY, FRAME SUB - P/N 166326

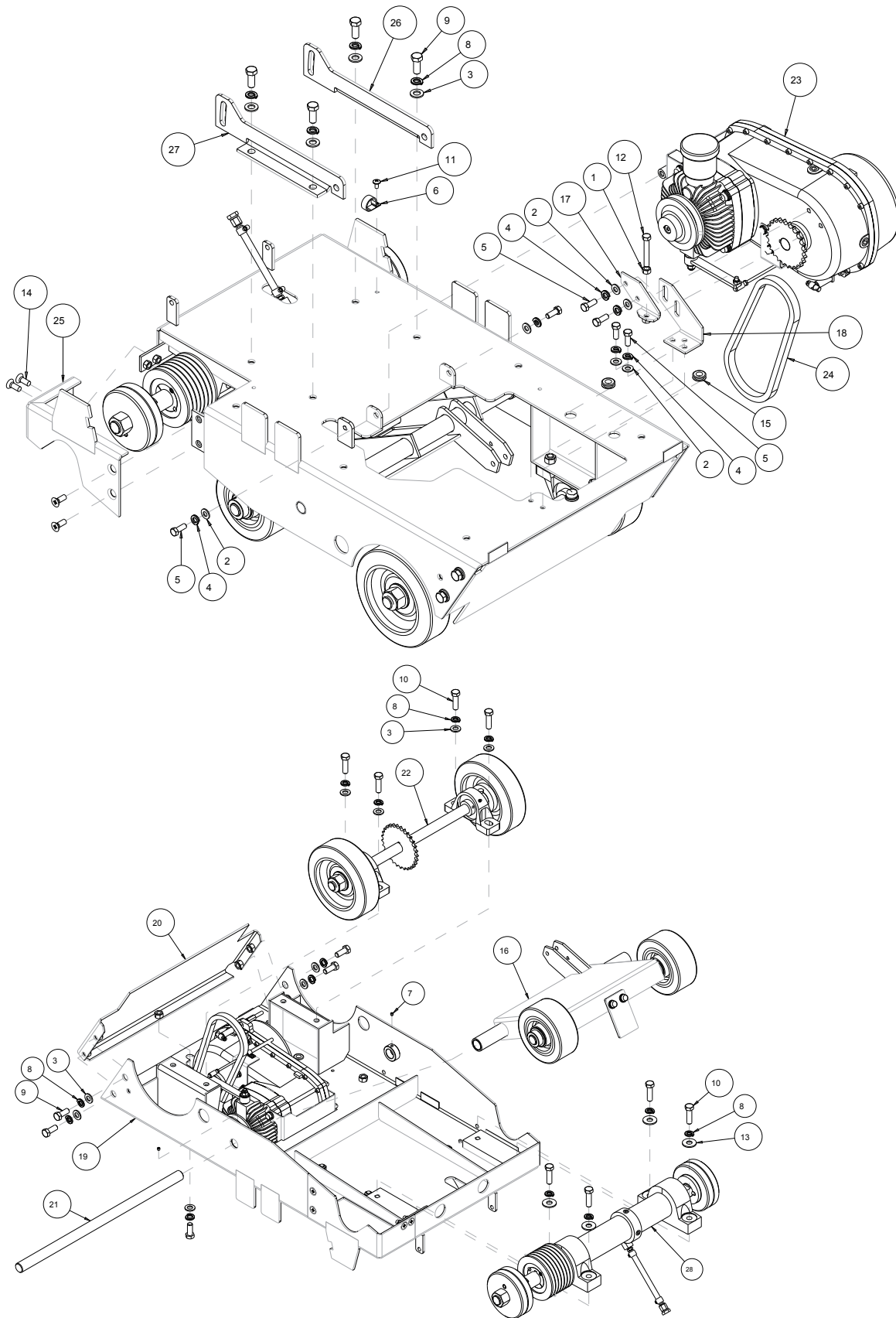

FIGURE 17 - PARTS LIST: ASSY, FRAME SUB - P/N 166326

ITEM NO.	DESCRIPTION	PART OR IDENTIFYING NO.	QTY. REQ.
1	NUT, 3/8 - 16 HEX	101188	1
2	WASHER, 3/8 SAE FLAT	150923	6
3	WASHER, 1/2 SPLIT LOCK	150924	13
4	WASHER, LOCK, SPLIT, 3/8	150925	6
5	SCREW, HEX HD CAP, 3/8 - 16 X 1	152507	6
6	CLAMP, 7/8 CUSHION LOOP	152593	1
7	SCREW, 5/16 - 18 X 1/2 SOCKET HEAD STE	152607	2
8	WASHER, 1/2 SPLIT LOCK	153524	17
9	SCREW, 1/2 - 13 X 1 - 1/4 HEX HEAD CAP	153532	9
10	SCREW, 1/2 - 13 X 1 - 1 - 3/4 HEX HEAD CAP	153853	8
11	SCREW, 1/4 - 20 X 1/2 TRUSS HEAD	153880	1
12	BOLT, 3/8 - 16 X 2 - 1/2 HEX HEAD CAP	155589	1
13	WASHER, FLAT, USS, 1/2	157679	4
14	SCREW, 3/8 - 16 X 1 FLATHEAD MACHINE	162067	4
15	GROMMET, 1/2 X 1.0	162493	2
16	ASSY, TRUCK	162742	1
17	BRACKET, TRANS LIFT, ADJ	162743	1
18	BRACKET, TRANS MOUNT FIXED	162744	1
19	FRAME, WELDMENT MAIN	166327	1
20	PLATE, REAR FRAME	166329	1
21	SHAFT, TRUCK PIVOT	166330	1
22	ASSY, AXLE, REAR	166331	1
23	ASSY, TRANSMISSION	166338	1
24	CHAIN, #40 ROLLER, W/LINK	166345	1
25	CORNER, MAIN FRAME	166350	1
26	BRACKET, ENG MOUNT, RH	169474	1
27	BRACKET, ENG MOUNT, LH	169475	1
28	ASSY, BLADE SHAFT	170034	1

FIGURE 18 - PARTS LIST: ASSY, BLADE SHAFT, P/N 170034

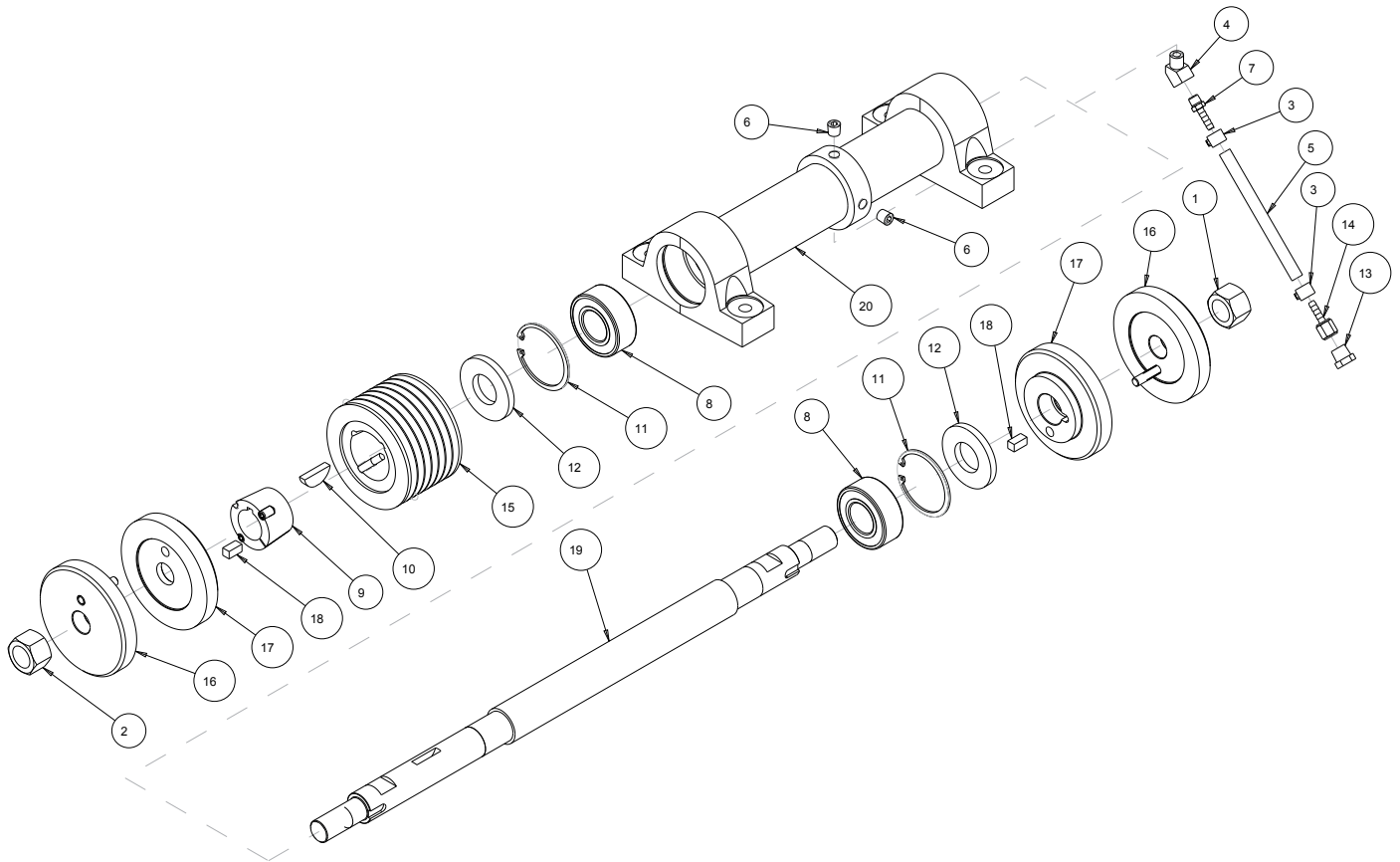
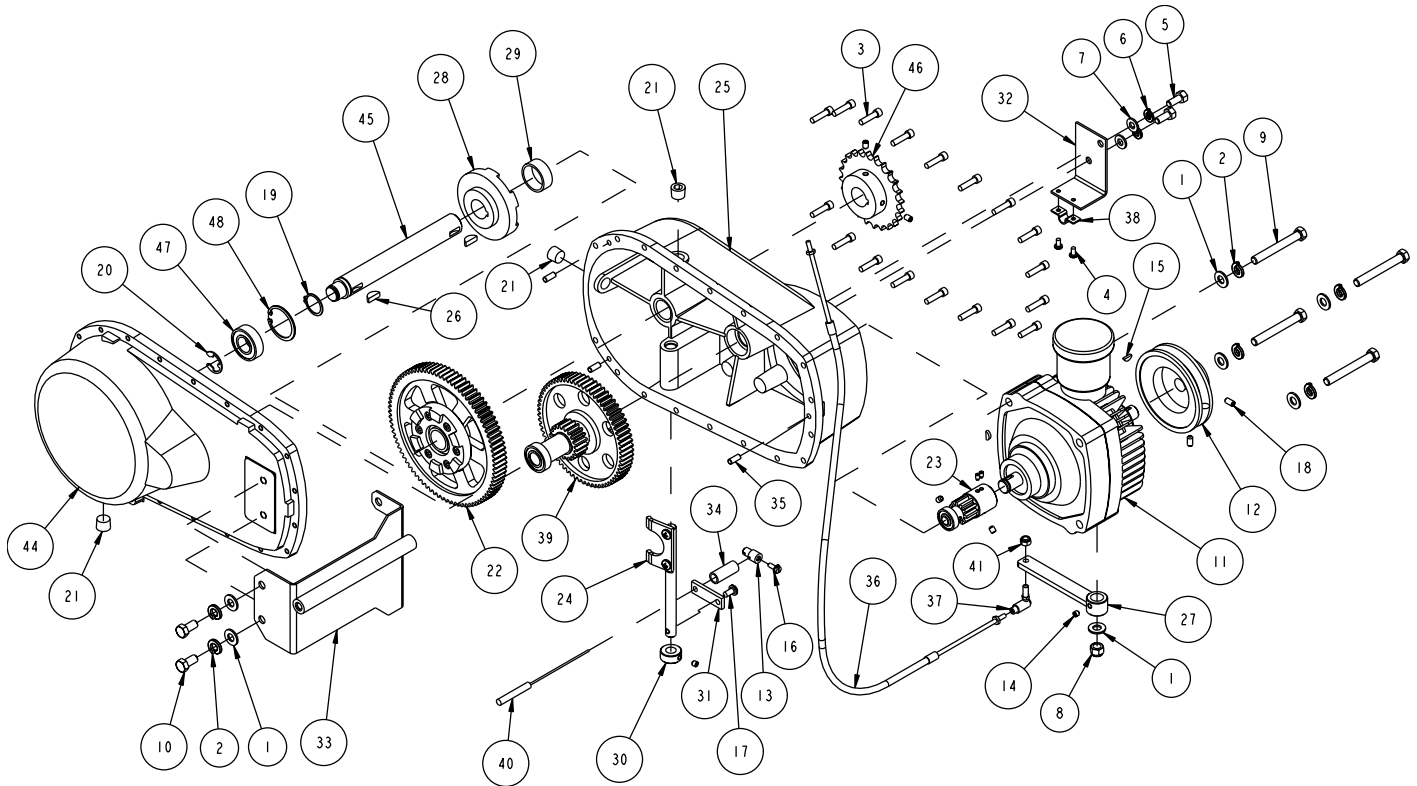

FIGURE 18 - PARTS LIST: ASSY, BLADE SHAFT, P/N 170034

ITEM NO.	DESCRIPTION	PART OR IDENTIFYING NO.	QTY. REQ.
1	NUT, 1 -14 RIGHT HAND	138693	1
2	NUT, 1 - 14 LEFT HAND	138701	1
3	CLAMP, HOSE, 5.8	151198	2
4	ELBOW, 1/4 NPT X 45 STREET	153869	1
5	HOSE, 1/4 FUEL, 6"	154163	1
6	PLUG, 1/4NPT HEX SOCKET	154679	2
7	FITTING, 1/8 MNPT X 1/4 BARB	155809	1
8	BEARING, 35 X 72 X 27, D-ROW BALL	160810	2
9	BUSING, TPR-LOCK, 1615 X 1 - 3/8	160811	1
10	KEY, WOODRUFF, 5/16 X 1 -1/2	160816	1
11	RING, RETAINING, 72MM INTERNAL	161201	2
12	SEAL, OIL, 1 - 3/8 X 72MM	161202	2
13	PLUG, 3/8NPT BRONZE BREATHER	161209	1
14	FITTING, 1/4 FNPT X 1/4 BARB	162601	1
15	PULLEY, 7/3V X 4.75 X 1615TB	165696	1
16	FLANGE, KEYED, INNER, 5"	168598-5	2
17	FLANGE, KEYED, INNER, 5"	168598-5	2
18	KEY, SQR, 3/8 X 3/4	169371	2
19	SHAFT, BLADE, ENCL. 300	170031	1
20	CASTING, SHAFT HOUSING, 3000-COMP	170033	1

FIGURE 19 - PARTS LIST: ASSY, TRANSMISSION - P/N 166338



ITEM NO.	DESCRIPTION	PART OR IDENTIFYING NO.	QTY. REQ.
1	WASHER, 3/8 SAE FLAT	150923	7
2	WASHER, 3/8 SPLIT LOCK	150925	6
3	SCREW, SOC HD CAP, 1/4-20 X 1	151049	18
4	SCREW, 10-24 X 3/8 PAN HEAD PHILLIPS MACHINE	151097	2
5	SCREW, 5/16-18 X 3/4 HEX HEAD MACHINE	151369	2
6	WASHER, LOCK, SPLIT, 5/16	151747	2
7	WASHER, FLAT, SAE, 5/16	151754	2
8	NUT, 3/8-16 NYLOK HEX	152505	1
9	SCREW, 3/8-16 X 3 HEX HEAD CAP	153113	4
10	SCREW, HEX, 3/8-16 X 3/4	153527	2

FIGURE 19 - PARTS LIST: ASSY, TRANSMISSION - P/N 166338

ITEM NO.	DESCRIPTION	PART OR IDENTIFYING NO.	QTY. REQ.
11	PUMP, TRANSMISSION	153783	1
12	PULLEY, A4.0 X 17 MM BORE OFFSET	153826	1
13	PIN, WIRE STOP	153842	1
14	SCREW, SET CNE PT 1/4-20 X 1/4	153864	1
15	KEY, WOODRUFF, 1/8 X 1/2	153865	2
16	SCREW, HEX HD FL 10-24 X 5/16	154172	1
17	SCREW, 1/4-20 X 1/2 PAN HEAD PHILLIPS MACHINE	155452	1
18	SCREW, 1/4-20 X 1/2 SOCKET HEAD SET	155804	2
19	RING, 1" EXTERNAL RETAINING	161140	1
20	RING, .75 E-STYLE RETAINING	161163	1
21	PLUG, 3/8 NPT HEX SOCKET, GALV	161208	3
22	ASSY, ENGAGEMENT GEAR	161233	1
23	ASSY, PUMP PINION	161235	1
24	ASSY, TRANS FORK 1	161237	1
25	ASSY, TRANS CASE 1	161248	1
26	KEY, WOODRUFF, 1/4 X 3/4	161261	2
27	LEVER, TRANS CONTROL	161263	1
28	PLATE, LOCKER, KEYED	161264	1
29	SPRING, 1.5OD X 1.3 COMPRESSION	161279	1
30	COLLAR, 1/2 SHAFT	162633	1
31	LEVER, TRANS FORK	162673	1
32	BRACKET, TRANS FNR	162735	1
33	BRACKET, TRANS PIVOT	162741	1
34	SPRING, .56 OD X 1.38 COMPRESSION	162829	1
35	PIN, 1/4 X 5/8 DOWEL	162849	3
36	CABLE, TRANS CONTROL	162858	1
37	BALL JOINT, 30 SERIES	162859	1
38	CLAMP, 30 SERIES CONDUIT	162860	1
39	ASSY, CHANGE GEAR	162883	1
40	CABLE, T2L CONTROL, N (COMP)	163934	1
41	NUT, HEX, NYLK, 1/4-28	163936	1
42	OIL, 80-90 SAE GEAR	164971	1
43	SEALANT, HI-TEMP FORM-A-GASKET	164972	1
44	CASTING, TRANS CASE3 (COMP)	166340	1
45	SHAFT, AXLE, #3	166341	1
46	SPROCKET, 40BS24 X 1.0 BORE	166342	1
47	BEARING, BALL, 20 X 42 X 12 MM	166343	1
48	RING, 1-11/16 INTERNAL RETAINING	166344	1

FIGURE 20 - PARTS LIST: ASSY, TRUCK - P/N 162742

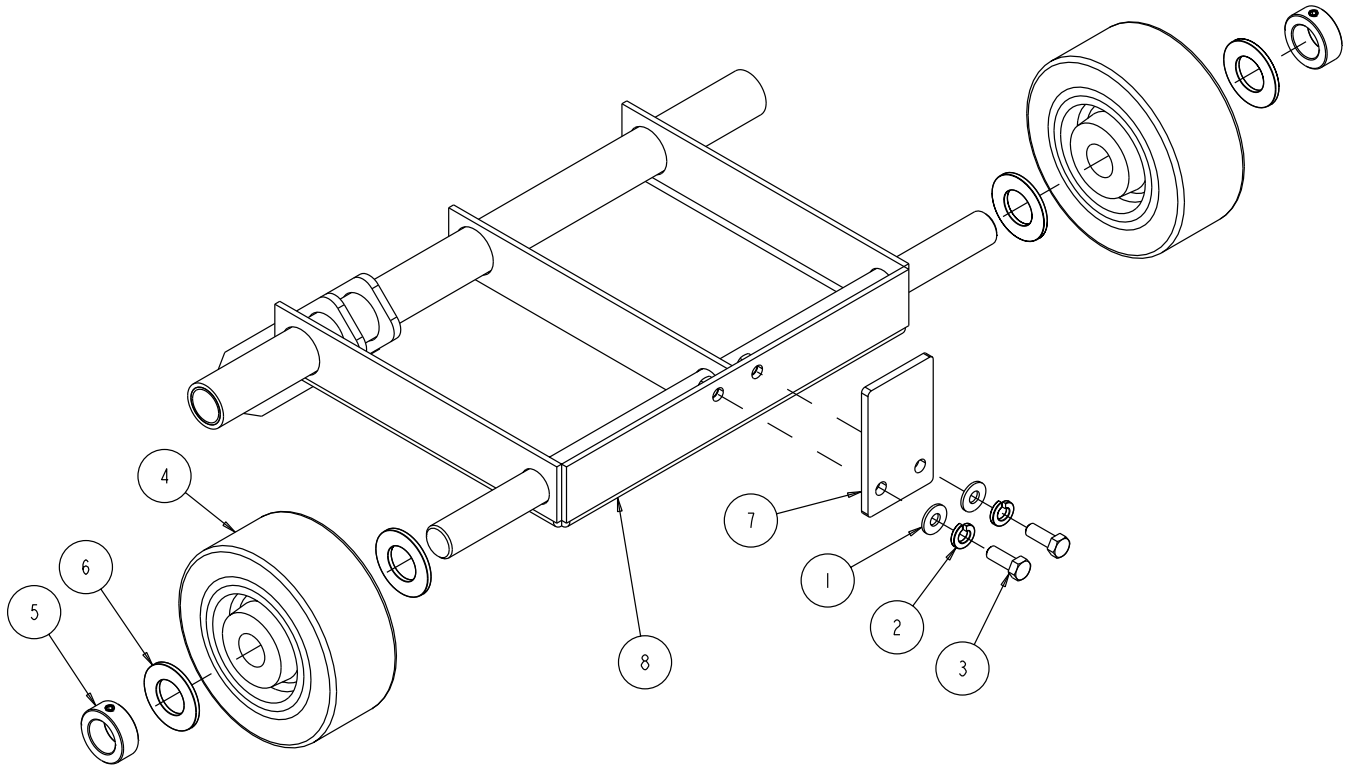

ITEM NO.	DESCRIPTION	PART OR IDENTIFYING NO.	QTY. REQ.
1	WASHER, 3/8 SAE FLAT	150923	2
2	WASHER, 3/8 SPLIT LOCK	150925	2
3	SCREW, HEX HD CAP, 3/8-16 X 1	152507	2
4	WHEEL, 6 X 2-1/2 X 1	160848	2
5	COLLAR, 1.0 SHAFT	160849	2
6	WASHER, 1 SAE FLAT	160851	4
7	STOP, TRUCK	162736	1
8	TRUCK	166328	1

FIGURE 21 - PARTS LIST: ASSY, AXLE, REAR - P/N 166331

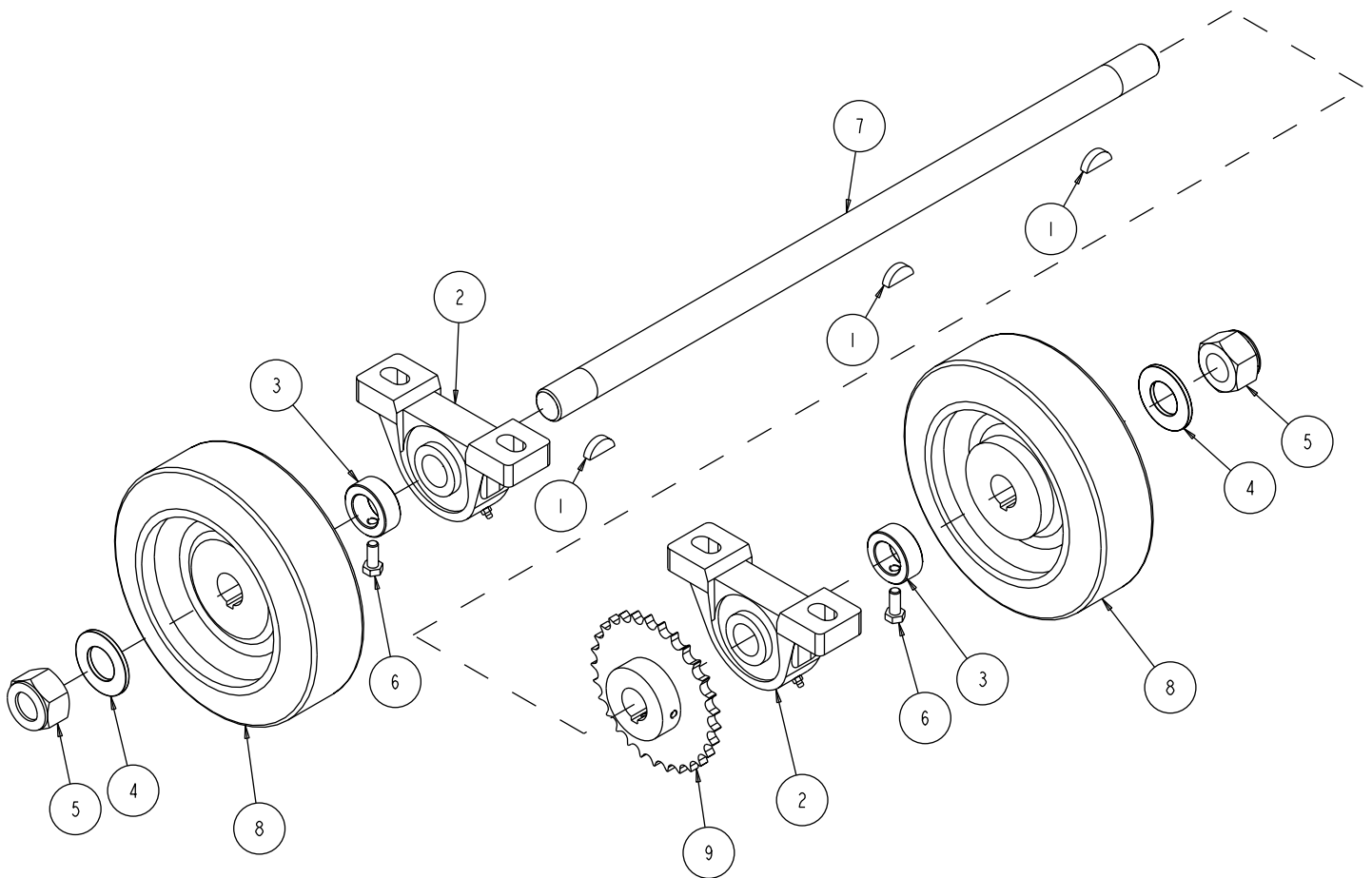

ITEM NO.	DESCRIPTION	PART OR IDENTIFYING NO.	QTY. REQ.
1	KEY, 1/4 X 1 WOODRUFF	150795	3
2	BEARING, 1.0 ID PILLOW BLOCK	157924	2
3	COLLAR, 1" SHAFT	160849	2
4	WASHER, 1 SAE FLAT	160851	2
5	NUT, 1-8 NYLOK HEX	163235	2
6	SCREW, 5/16-24 X 3/4 HEX HEAD MACHINE	165617	2
7	SHAFT, REAR AXLE	166332	1
8	WHEEL, 8 X 2-1/2 X 1.0 BORE	166333	2
9	SPROCKET, 40BS29 X 1.0 BORE	166334	1

FIGURE 22 - PARTS LIST: ASSY, FUEL TANK, GASOLINE - P/N 166357

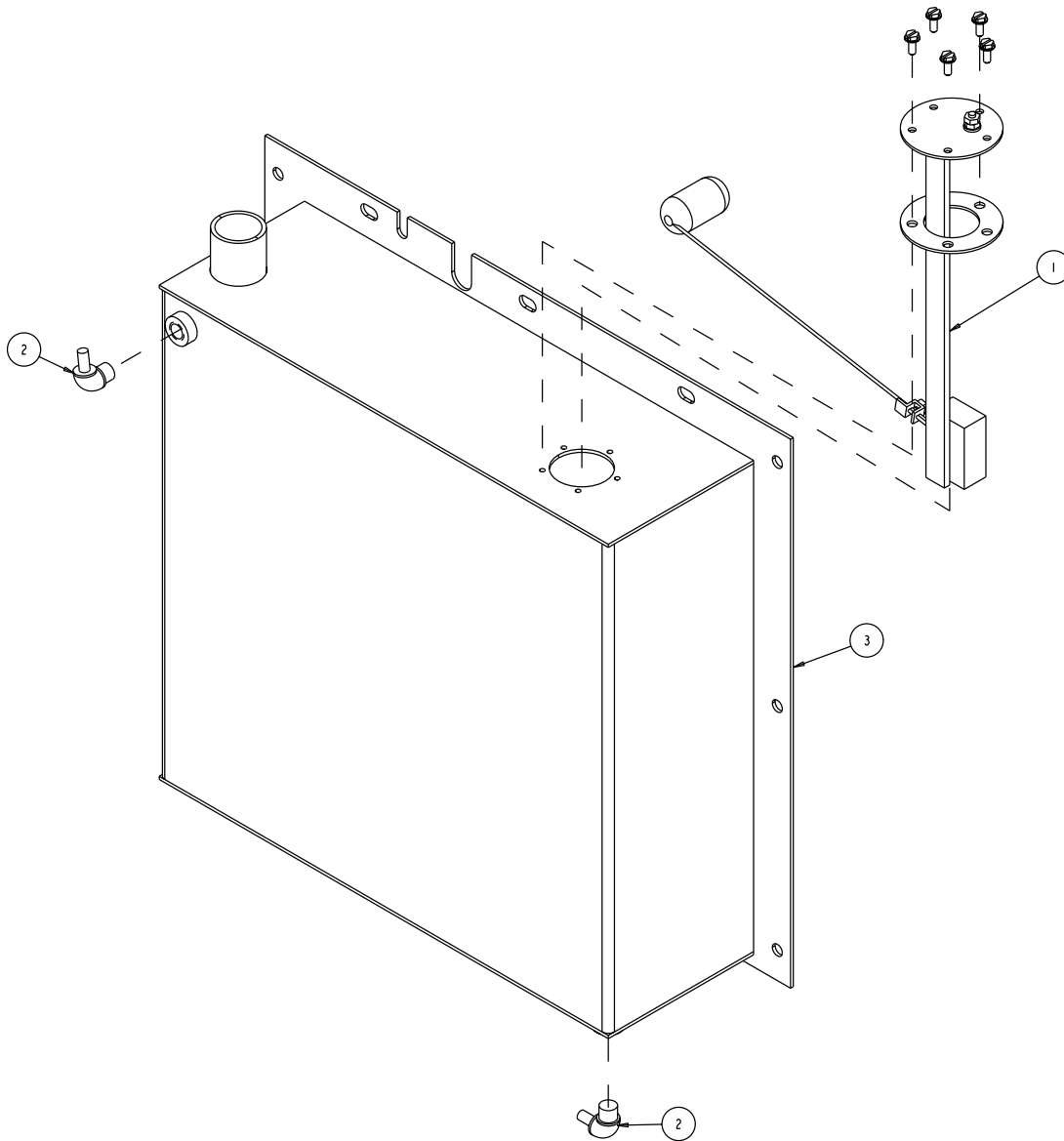

ITEM NO.	DESCRIPTION	PART OR IDENTIFYING NO.	QTY. REQ.
1	SENDER, FUEL	162636	1
2	ELBOW, 1/4 MNPT X 1/4 BARB, 90 DEG	162637	2
3	TANK, FUEL	166358	1

FIGURE 23 - PARTS LIST: ASSY, POINTER - P/N 162732

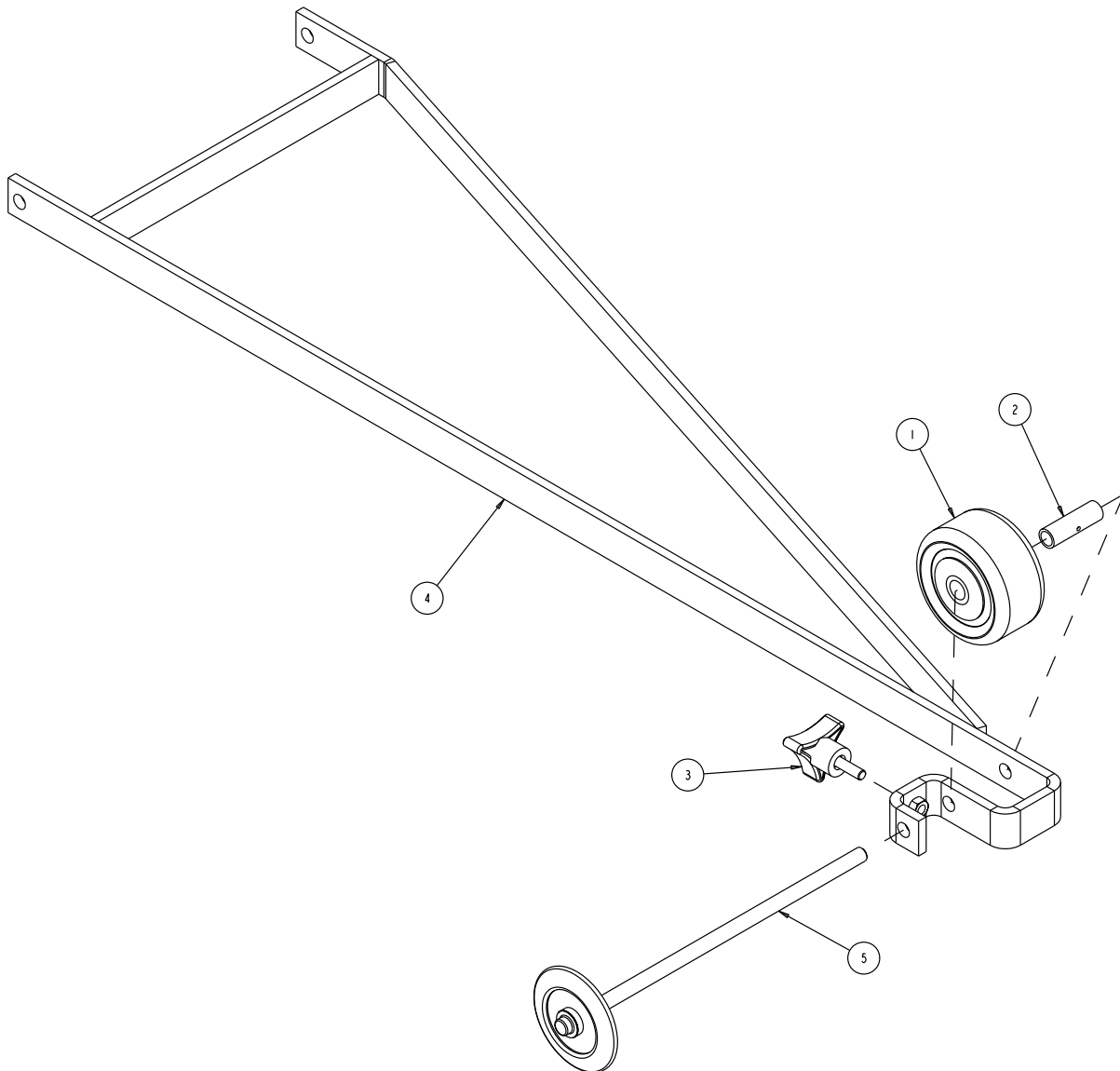

ITEM NO.	DESCRIPTION	PART OR IDENTIFYING NO.	QTY. REQ.
1	WHEEL, POINTER, 3"	155066	1
2	BUSHING, 3/8 ID X 1-5/8L	155153	1
3	KNOB, 1/4-20 3/4 PRONG, NO LOGO	160482	1
4	ARM, POINTER	162733	1
5	ASSY, POINTER WHEEL	165238	1

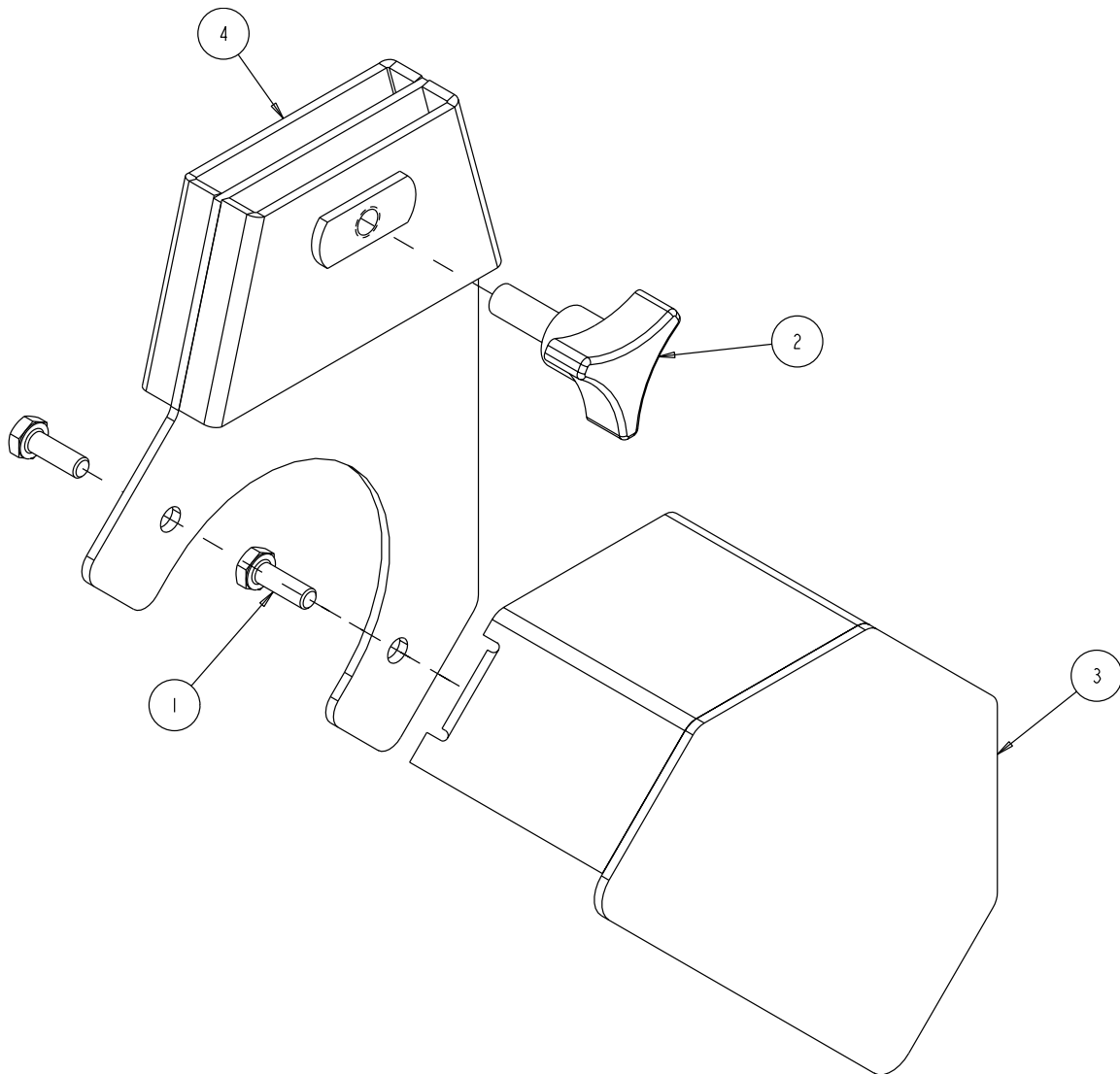
FIGURE 24 - PARTS LIST: ASSY, SHAFT GUARD - P/N 166056

ITEM NO.	DESCRIPTION	PART OR IDENTIFYING NO.	QTY. REQ.
1	SCREW, HEX HD 1/4-20 X 3/8	153526	2
2	KNOB, 3 PRONG 3/8-16 X 1	156175	1
3	GUARD, SHAFT	161109	1
4	BACK PLATE, SHAFT GUARD	166057	1